



BENDER
CONNECT

LINETRAXX® SmartDetect RCMS410

Four-channel residual current monitor sensitive to AC, pulsed DC, and smooth DC for earthed AC, AC/DC, and DC systems



Service and support for Bender products

First-level support

Technical support

Carl-Benz-Strasse 8 • 35305 Gruenberg • Germany

Telephone: +49 6401 807-760

0700BenderHelp *

Fax: +49 6401 807-629

E-mail: support@bender-service.de

Available from 7.00 a.m. to 8.00 p.m. 365 days a year (CET/UTC+1)

* Landline German Telekom: Mon-Fri from 9 a.m. to 6 p.m.: 6.3 cents/30 sec.; remaining time: 6.3 cents/min.

Mobile phone: higher, depending on mobile phone tariff

Repair service

Repair, calibration and replacement service

Londorfer Strasse 65 • 35305 Gruenberg • Germany

Telephone: +49 6401 807-780 (technical issues) or

+49 6401 807-784, -785 (commercial issues)

Fax: +49 6401 807-789

E-mail: repair@bender-service.de

Field service

On-site service

Telephone: +49 6401 807-752, -762 (technical issues) or

+49 6401 807-744 (commercial issues)

Fax: +49 6401 807-759

E-mail: fieldservice@bender.de

Mon-Thu 7.00 a.m. to 4.00 p.m., Fri 7.00 a.m. to 1.00 p.m. (CET/UTC +1)

Table of Contents

1	General instructions	7
1.1	How to use this manual	7
1.2	Indication of important instructions and information	7
1.3	Signs and symbols	7
1.4	Training courses and seminars.....	7
1.5	Delivery conditions.....	7
1.6	Inspection, transport, and storage	8
1.7	Warranty and liability.....	8
1.8	Disposal of Bender devices.....	8
1.9	Safety	8
1.10	Intended use	9
2	Function	10
2.1	Device features	10
2.2	Functional description	10
2.2.1	Connection monitoring	12
2.2.2	Manual self test.....	12
2.2.3	Malfunction	12
2.2.4	Delay times t_{br} , t_r , t_{onr} and t_{off}	12
2.2.5	Factory settings FAC	13
2.2.6	Fault memory	13
2.2.7	Channel functions.....	13
2.2.8	Preset function	14
2.2.9	Reload function.....	14
2.2.10	NFC interface	15
2.3	Function modules	16
2.3.1	Function module A: Harmonic analysis (FFT)	16
2.3.2	Function module B: AC/DC sensitive measuring and evaluation of values	16
2.3.3	Function module C: Connection of Type A external current transformers.....	16
2.3.4	Function module D: History memory (in preparation)	16
3	Mounting and connection.....	17
3.1	Mounting.....	17
3.2	Connecting the RCMS410.....	18
3.2.1	Connections overview	18
3.2.2	Wiring diagram	19
3.2.3	Supply voltage U_s	19

4	Interfaces	20
4.1	Digital inputs and outputs (overview)	20
4.2	Output M+	20
4.2.1	Digital mode	20
4.2.2	Analogue mode	22
4.3	Digital input and output Q.....	23
4.4	Digital input I	25
4.5	Inputs CT1...4.....	26
4.5.1	Measuring-current-transformer connection	26
4.5.2	Connection of CTs of other manufacturers.....	28
4.5.3	CT1...4 as digital input	28
4.6	RS-485 interface.....	29
5	Operation and settings on the device	30
5.1	RCMS410 front panel (overview)	30
5.2	STATUS LED	30
5.3	ALARM LEDs.....	31
5.4	CHANNEL-INDICATION LEDs.....	31
5.5	T/R BUTTON.....	31
5.5.1	"RESET" function	32
5.5.2	"TEST" function.....	32
5.5.3	"NFC" function.....	32
5.5.4	"ADDR" function	32
5.5.5	"PROTECT" function	33
5.6	Harmonic analysis	33
6	Modbus interface	34
6.1	Overview.....	34
6.2	Read and write permissions	34
6.3	Data types	34
6.4	Register ranges	34
6.5	Device-information registers	35
6.6	Alarm/measuring value registers	36
6.7	Monitoring-functions registers	38
6.8	Status-information registers	38
6.9	Harmonic-analysis registers	39
6.10	THD, RMS registers, H1...400	43
6.11	Modbus-parameter registers.....	44
6.12	Registers of digital input "I".....	44
6.13	Registers of input/output "Q"	45
6.14	Registers of output "M+"	46
6.15	Registers of response-value parameters	47
6.16	Function and operating-characteristics registers	48

6.17	Alarm-behaviour registers	49
6.18	Time-behaviour registers	49
6.19	Monitoring-functions registers	49
6.20	Measuring-current-transformer registers	50
6.21	Device-error-code registers.....	50
6.22	Control-commands registers.....	52
6.23	Function-control-commands registers	52
7	Error – Cause – Error correction	54
8	Technical data.....	55
8.1	Frequency responses of the filters.....	55
8.2	Tabular data	57
8.3	Standards & certifications	58
8.4	Licences	58
8.5	Declaration regarding the radio system.....	58
8.6	Ordering information	59
8.7	Document revision history	59

1 General instructions

1.1 How to use this manual



This manual is intended for qualified personnel working in electrical engineering and electronics! In addition to this manual, the enclosed "Safety instructions for Bender products" are part of the device documentation.



Read the manual before mounting, connecting and commissioning the device. Always keep the manual within easy reach for future reference.

1.2 Indication of important instructions and information



DANGER! Indicates a high risk of danger that will result in death or serious injury if not avoided.



WARNING! Indicates a medium risk of danger that can lead to death or serious injury, if not avoided.



CAUTION! Indicates a low-level risk that can result in minor or moderate injury or damage to property if not avoided.



Information can help to optimise the use of the product.

1.3 Signs and symbols



Disposal



Recycling



Temperature range



Protect from moisture



Protect from dust



RoHS directives

1.4 Training courses and seminars

www.bender.de > [Know-how-> Seminars.](#)

1.5 Delivery conditions

The conditions of sale and delivery set out by Bender apply. These can be obtained from Bender in printed or electronic format.

The following applies to software products:



["Software clause in respect of the licensing of standard software as part of deliveries. Amendments and modifications to general delivery conditions for products and services in the electrical industry."](#)

1.6 Inspection, transport, and storage

Check the shipping and device packaging for transport damage and scope of delivery. The following must be observed when storing the devices:



1.7 Warranty and liability

Warranty and liability claims in the event of injury to persons or damage to property are excluded in case of:

- Improper use of the device.
- Incorrect mounting, commissioning, operation and maintenance of the device.
- Failure to observe the instructions in this operating manual regarding transport, commissioning, operation and maintenance of the device.
- Unauthorised changes to the device made by parties other than the manufacturer.
- Non-observance of technical data.
- Repairs carried out incorrectly.
- Use of accessories and spare parts not recommended by Bender.
- Catastrophes caused by external influences and force majeure.
- Mounting and installation with device combinations not recommended by the manufacturer.

This operating manual and the enclosed safety instructions must be observed by all persons working with the device. Furthermore, the rules and regulations that apply to accident prevention at the place of use must be observed.

1.8 Disposal of Bender devices

Abide by the national regulations and laws governing the disposal of this device.



For more information on the disposal of Bender devices, refer to

www.bender.de > [Service & Support](#).

1.9 Safety

If the device is used outside the Federal Republic of Germany, the applicable local standards and regulations must be complied with. In Europe, the European standard EN 50110 applies.

***DANGER! Risk of electrocution due to electric shock!***

Touching live parts of the system carries the risk of:

- *An electric shock*
- *Damage to the electrical installation*
- *Destruction of the device*

Before installing the device and before working on its connections, make sure that the installation has been de-energised. The rules for working on electrical systems must be observed.

1.10 Intended use

The RCMS410 device in conjunction with the specified measuring-current transformers (CT) is intended for AC, pulsed DC, and smooth DC sensitive residual-current measurement according to IEC 62020-1.

Its area of application is the monitoring of residual currents I_{Δ} for preventive maintenance in TN, TT and IT systems with $I_{\Delta} \leq 120$ A peak, where I_{Δ} is intended to be measured within a range of $f = \text{DC} \dots 20$ kHz.

The devices are intended for operation in control cabinets or similarly protected environments. For intended operation, observe the specifications in this manual.

Any other use than that described in this manual is regarded as improper.

2 Function

2.1 Device features

- AC, pulsed-DC, and smooth-DC sensitive residual-current monitor type A, type F, type B and type B+ according to IEC 62020-1 (depending on the connected measuring-current transformers and activated function modules)
- Four channels
- Measurement modes for each channel: overcurrent (standard), undercurrent, or window mode (out-of-range-values). Every channel can alternatively also be configured as digital input
- One digital input, one digital input/output, and one multifunctional digital/analogue output
- Measurement of the r.m.s. value
- Residual operating current
 - Type A: 6 mA...30 A
 - Type F: 6 mA...30 A (15 Hz...20 kHz)
 - Type B/Type B+: 10 mA...10 A
(only with function module B "AC/DC sensitive measuring and evaluation of values")
- Separate evaluation of AC/DC (RMS), AC, and DC
- Prewarning: 10...100 % of the residual operating current
- Supply voltage 24 V DC
- Alarm-LED for each channel
- Device status and Alarm LEDs
- Fault-memory behaviour selectable
- RS-485 with Modbus RTU
- NFC interface for device parameter setting via Bender Connect App with the device energised or de-energised
- Continuous CT-connection monitoring
- Expanded functions available by enabling these function modules:
 - AC/DC sensitive measuring and evaluation of values
 - Harmonic analysis (FFT)
 - Connection of Type A external transformers
 - History memory (in preparation)

2.2 Functional description

Once the supply voltage U_s has been applied and the recovery time t_0 has elapsed, the start-up delay t begins. During the start-up delay t no alarms are reported. Residual-current measurement and evaluation is carried out via an external measuring-current transformer. If the measured value exceeds or falls below the specified value for the prewarning and/or the residual operating current, the response delay t_{on} starts.

After t_{on} has elapsed, a prewarning or a main alarm is given via the corresponding outputs and interfaces, and the corresponding alarm LED lights up. If the value reaches the release value before t_{on} has elapsed, no alarm is signalled: The LEDs AL1, AL2 do not light up, and no prewarning or

main alarm is signalled via an interface. The set release time t_{off} starts when, after the alarm status was triggered, the measured value again reaches the release value. Once t_{off} has elapsed, the device switches back to its initial status.

When the storing of a fault in the memory is enabled, the prewarning or main alarm is given via the interfaces and LEDs until a reset is performed. A reset can be carried out via the interface, the digital input or the combined test/reset button (T/R).

Every measuring channel can alternatively also be configured as digital input. In this case, the status of the digital input is output via the interfaces. The functions of t_{on} , t_{off} and storing of a fault in the memory are active also here.

The T/R button can also be used to test the device, to enable and disable the NFC function, to define a write-protection, and to set the Modbus device address.

When the function "starts in alarm status" (see Modbus register 32804...32807) has been selected for one or more channels, all the alarms are set on the corresponding channel(s) when the device is started. Only when the device start has been ended and the device is ready for measuring, no limits have been violated, and no error messages are active, will the alarms be reset.

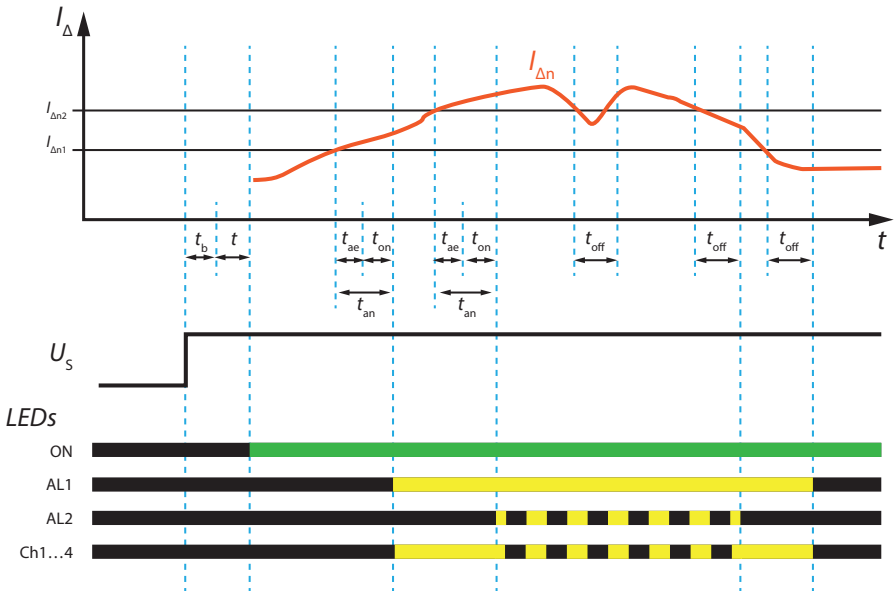

Fig. 2-1 Timing diagram of RCMS410

2.2.1 Connection monitoring

The connections to the measuring-current transformers are continuously monitored. In the event of a fault, a message is output via the interfaces, and the status LED as well as the channel LED of the faulty connection flash yellow. After the fault has been eliminated, the device automatically switches back to its initial status, and the status LED lights up green. When the storing of a fault in the memory is enabled, alarm messages are deleted only by a reset. Until then the corresponding LEDs flash yellow.

2.2.2 Manual self test

When the T/R-button is operated (3...6 s), the device simulates an alarm status. All LEDs are illuminated, and the outputs are activated. The alarm messages are output via the corresponding interfaces. When the storing of a fault in the memory is enabled, the alarm LEDs and the outputs remain active until the fault memory is cleared by means of a reset.

i *Users need to carry out the manual self test periodically (at least every 6 months).*

2.2.3 Malfunction

In the event of an internal malfunction, the green status LED changes its colour to red or yellow. The error code can be queried via the device interfaces.

2.2.4 Delay times t_b , t , t_{on} and t_{off}

The times t_b , t , t_{on} and t_{off} described below delay the output of alarms via LEDs, digital outputs, and Modbus RTU.

Recovery time t_b

The recovery time is the time the device needs to be ready for measurement after the supply voltage U_s has been connected.

Start-up delay t

After the supply voltage U_s has been connected, the measuring function is delayed by the set time t (0...999 s) plus the recovery time t_b .

Response delay t_{on}

If values exceed or fall below the defined residual-operating-current limits, the residual current monitor needs the response time t_{an} to output the alarm. A set response delay t_{on} (0...10 s) is added to the device-specific operating time t_{ae} and delays signalling:

Response time $t_{an} = t_{ae} + t_{on}$

If the fault does not persist during the response delay, the alarm is not signalled.

Delay on release t_{off}

If the alarm no longer exists and the storing of a fault in the memory has been disabled, the alarm LEDs go out and the device switches back to its initial status. By means of the delay on release (0...999 s), the alarm state is maintained for the selected period.

2.2.5 Factory settings FAC

There are two ways to carry out a reset:

Factory settings without interface

After restoring the factory settings, all previously changed settings are reset to the state upon delivery. The settings for the Modbus interface are not reset.

Factory settings with interface

After restoring the factory settings, all previously changed settings including the settings for the Modbus interface and the device address are reset to the state upon delivery.

i *These settings are configured in Modbus registers 60000...60003, function 4.*

2.2.6 Fault memory

The storing of a fault in the memory can be enabled or disabled. When the fault memory is enabled, stored alarms can be reset by performing a reset. The storing of a fault in the memory is factory-set to disabled.

2.2.7 Channel functions

i *The settings for the channel functions are configured in Modbus registers 32700...32703.*

Measuring-current-transformer connection

For each channel either the overcurrent, undercurrent, or window function can be selected (register content 32700...32703: 1, 2, or 3)

- **Overcurrent function:**

Prewarning when measured value > prewarning response value or main alarm when measured value > residual operating current $I_{\Delta n}$

- **Undercurrent function:**

Prewarning when measured value < prewarning response value or main alarm when measured value < residual operating current $I_{\Delta n}$

i *Note that with the **undercurrent function** the response value of the prewarning is higher than the residual operating current $I_{\Delta n}$. See Modbus-register table for an explanation on how to proceed.*

- **Window mode:** An alarm is given when the values fall or rise outside the range formed by the response values for a prewarning and for a main alarm $I_{\Delta n}$

i *The settings for the response values are configured in Modbus registers 32600...32635.*

CT1...4 as digital input

Every measuring channel can alternatively also be configured as digital input (content of registers 32700...32703: 4 or 5). In this event, the status of the digital input is output via the interfaces. For details see chapter „CT1...4 as digital input“.

Disabling unused channels

When a measuring channel is not connected, it must be disabled (content of registers 32700...32703: 6)

2.2.8 Preset function

With the adjustable preset function default values of the response values can be set for all channels. For this, the currently measured value is taken into account for every channel. The response value is calculated by multiplying the currently measured value with a preset factor and then adding a preset offset value.

$$I_{\Delta n} = I_{\Delta} \times \text{preset factor} + \text{preset offset}$$

i *These settings are configured in Modbus registers 32713 and 32714.*

2.2.9 Reload function

When faults occur only for a limited time but repeatedly in the monitored system while the storing of faults in the memory is disabled, the alarm outputs would switch over to the fault status simultaneously. The reload function permits limiting the number of these switch-overs. As soon as the specified number is reached, the alarm message at the respective output remains active, and switch-overs are suspended until a reset is performed (= fault memory). When an adjustable time period has passed between two alarms, the counter is reset, while the alarm message does not remain active.

i *The settings for this are performed in Modbus registers 32418 and 32419 (input/output Q) or 32520 and 32521 (output M+).*

2.2.10 NFC interface

The NFC interface can be used to transmit a previously configured device parameter setting directly to the RCMS410.

i *This function is available only via the Bender Connect App. You can find this app in the Appstores for [iOS](#) and [Android](#).*



In the Bender Connect app the device first needs to be made known. Then the device-specific setting options are shown so that they can be configured. When the data is transferred, feedback is given whether the parameter configuration has been successful.

The NFC antenna is located at the front on the righthand side of the RCMS410. Parameter settings can be configurd via the Bender Connect app by holding the mobile phone to the NFC logo at the front or at the right side panel.

When a device is de-energised, a parameter setting can be transferred via the Bender Connect app. This setting is then activated automatically when the device is connected to the power supply.

Parameters can be configured via the Bender Connect App also when the device is energised. For this purpose, the NFC interface first needs to be activated in the device via the T/R button at the front of the device or via the Modbus interface.

2.3 Function modules

To expand its application range, optionally function modules can be enabled for the RCMS410. These function modules can be ordered and activated both when first ordering the device and also later on.

2.3.1 Function module A: Harmonic analysis (FFT)

Function module A permits analysing harmonics.

i *With ordering number B84604042 the harmonic analysis is already enabled as a default.*

2.3.2 Function module B: AC/DC sensitive measuring and evaluation of values

All RCMS410 devices evaluate measuring-current transformers of the types "A" and "F". With function module B also measuring-current transformers of the types "B" and "B+" can be used.

i *With ordering numbers B84604041 and B84604042 the AC/DC-sensitive measuring and evaluation of values is already enabled as a default.*

2.3.3 Function module C: Connection of Type A external current transformers

Function module C permits the use of measuring-current transformers by manufacturers other than Bender. When an external current transformer is used, a number of turns must be selected in the corresponding Modbus register (33104...33107).

i *With ordering number B84604042 the connection of external current transformers is already enabled as a default.*

2.3.4 Function module D: History memory (in preparation)

3 Mounting and connection

i Only qualified personnel are permitted to carry out the work necessary to install, commission and run a device or system.



Risk of electrocution due to electric shock! Touching live parts of the system carries the risk of:

- A fatal electric shock
- Damage to the electrical installation
- Destruction of the device

Before installing the device and before working on its connections, make sure that the installation has been de-energised. The rules for working on electrical systems must be observed.

3.1 Mounting

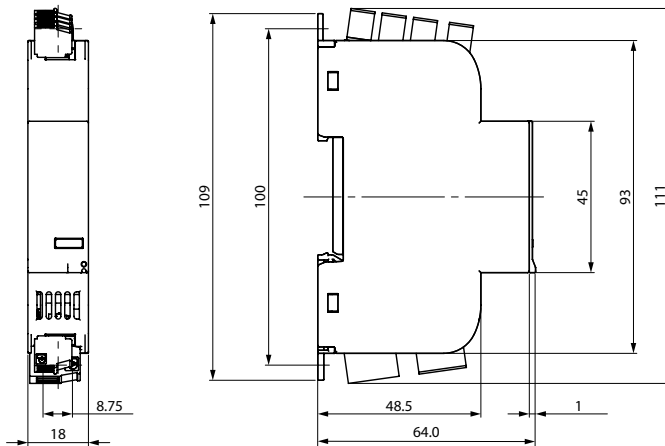

Fig. 3-2 Dimension diagrams (in mm)

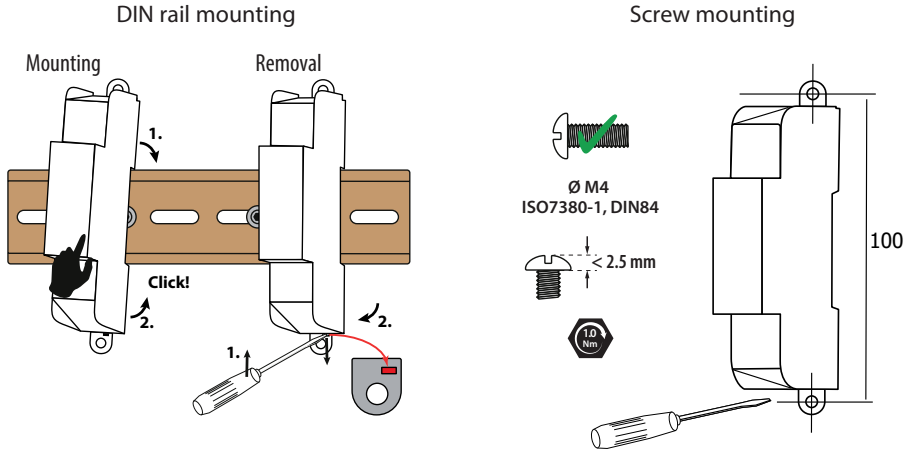

Fig. 3-3 Mounting

3.2 Connecting the RCMS410

3.2.1 Connections overview

		Terminal	Connection
Top	S1, S2 (CT4)		Measuring-current transformer CT4
	S1, S2 (CT3)		Measuring-current transformer CT3
	S1, S2 (CT2)		Measuring-current transformer CT2
	S1, S2 (CT1)		Measuring-current transformer CT1
Bottom	+		Supply voltage 24 V DC
	-		
	A		RS-485 A - Modbus RTU
	B		RS-485 B - Modbus RTU
	ON (R)		Termination of RS-485 interface
	M+		Multifunctional output
	Q		Digital input/output (configurable)
I		Digital input	
⊥		Ground	

Fig. 3-4 Connections of RCMS410-1

The cables are connected to the device via plug-in terminals. The maximum permissible conductor cross section is 1.5 mm².

3.2.2 Wiring diagram

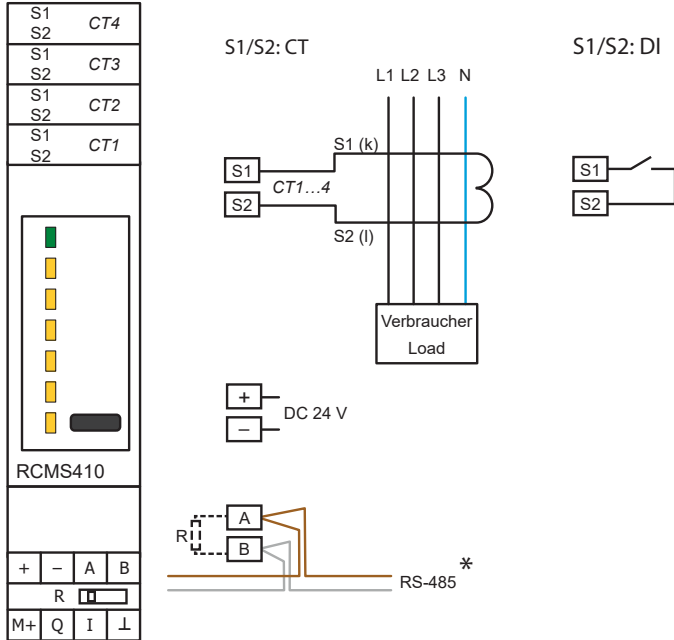

Fig. 3-5 RCMS410 wiring diagram

Legend for wiring diagram

- * For details see „RS-485 interface“
- S1/S2: CT Measuring-current-transformer connection
- S1/S2: DI CT1...4 as digital input

- i** The RCMS410 and all connected CTUB102-CTBCxx devices must be supplied from the same power supply.
- i** Ensure that the 24-V-DC supply is connected correctly. Otherwise the RCMS410 can be destroyed!
- i** **For UL applications:**
Use 60/75 °C copper conductors only!

3.2.3 Supply voltage U_s



The device must be operated with a voltage of 24 V DC. The connection is made at the bottom side of the device.

- i** Only power supply units of protection class 2 or 3 shall be used.

4 Interfaces

4.1 Digital inputs and outputs (overview)

	Element	Explanation
	M+	Multi-functional output <ul style="list-style-type: none"> Digital output: Signalling device states Analogue voltage or current output: For the direct connection of analogue instruments that analyse and display measured values.
	Q	Digital input/output <ul style="list-style-type: none"> Input: Performing tests and/or resets. Output: Signalling device states
	I	Digital input Performing tests and/or resets, can be configured with low-active and high-active.
	L	GND connection of the inputs/outputs

i During commissioning an output signal should be verified via an alternative route (e.g. the Modbus interface or the behaviour of a different output).
When the analogue/digital outputs are used, redundant monitoring is always recommended (for instance via the interface or a further output).

4.2 Output M+

M+ is a multi-functional digital/analogue output with reference to GND of the measuring sensor's inputs/outputs.

4.2.1 Digital mode

Settings in registers 32500...32501

The following settings can be assigned to output M+ in digital mode:

High-active: In the active mode +24 V are applied to output M+ internally.

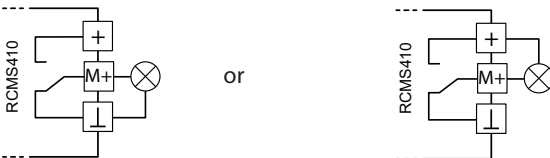

Low-active: In the active mode the GND potential is applied to output M+.

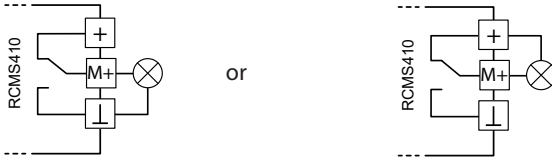

In the passive mode an external voltage can be connected (see Technical data). The output switches the applied potential to GND.

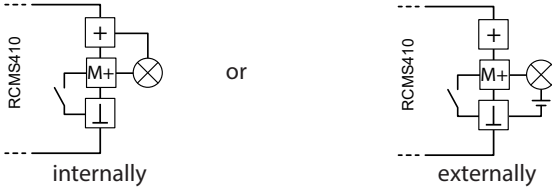

Permanently high: The output is permanently set to +24 V. In this manner e. g. an additional reference for the digital input can be created.

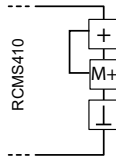

Permanently low: The output is permanently switched to GND. In this manner e. g. an additional reference for the digital input can be created.

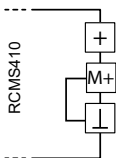

Alarm assignments permit assigning the following alarms to the output M+ in digital mode (registers 32504...32519):

Prewarning (AL1) AC/DC/RMS CH1...4	The output becomes active if AL1 of the selected measuring channel is present.
Main alarm (AL2) AC/DC/RMS CH1...4	The output becomes active if AL2 of the selected measuring channel is present.
CT-connection fault CH1...4	The output becomes active if a CT-connection fault (short circuit or interruption) of the selected measuring channel is present.
Overloading of the measuring channels	The output becomes active if the measuring function no longer works properly since the residual current is too high.
Device error	The output becomes active when a device error is present.
Test	The output becomes active in the course of a manual self test in accordance with the test process.

The reload settings (number of repeated connection attempts) are configured in registers 32520 and 32521.

4.2.2 Analogue mode

Settings in registers 32500...32503

The RMS value of a channel (CH1...4) is allocated to M+ as analogue output. Here a DC voltage or DC current signal that is proportional to the measured value is present at the output. The maximum scale value can be configured.

The following settings can be assigned:

Current output: 0-20/4-20 mA Voltage output: 0-10/2-10 V

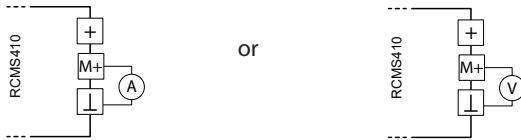

The maximum scale value corresponds to $I_{\Delta n, RMS}$ or it can be set at will up to $5 \times I_{\Delta n, max}$, 65 A.

The overview shows how the measured values I_{Δ} (A) of the output signals (in A or V) are shown as proportional values.

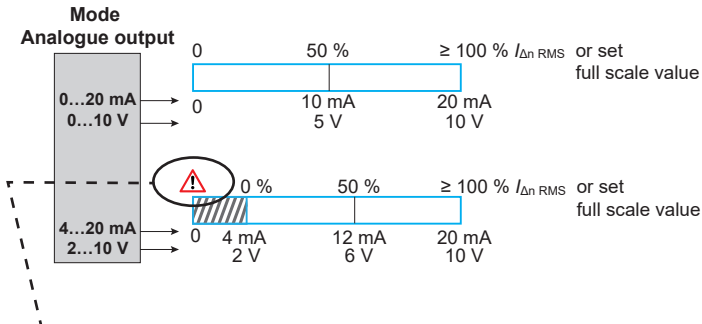

i



In the 4...20 mA or 2...10 V mode an output value of 0 mA or 0 V is a sign of a wiring fault of the analogue interface.

4.3 Digital input and output Q

Settings in registers 32400...32419

Q is a configurable digital input and output with reference to GND of the measuring sensor's inputs/outputs.

When it is used as an input, a test or reset can be triggered (register 32401).

When it is used as an output, the following alarms can be assigned via the alarm assignments (registers 32402...32417):

Prewarning (AL1) AC/DC/RMS CH1...4	The output becomes active if AL1 of the selected measuring channel is present.
Main alarm (AL2) AC/DC/RMS CH1...4	The output becomes active if AL2 of the selected measuring channel is present.
CT-connection fault CH1...4	The output becomes active if a CT-connection fault (short circuit or interruption) of the selected measuring channel is present.
Overloading of the measuring channels	The output becomes active if the measuring function no longer works properly since the residual current is too high.
Device error	The output becomes active when a device error is present.
Test	The output becomes active in the course of a manual self test in accordance with the test process.

The reload settings (number of repeated connection attempts) are configured in registers 32418 and 32419.

Input

The following settings can be assigned to input Q:

High-active: Event is carried out, when the digital input undergoes a signal change from low to high.

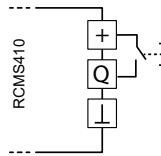

Low-active: Event is carried out, when the digital input undergoes a signal change from high to low.

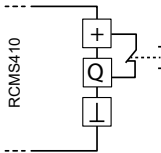

Output

The following settings can be assigned to output Q:

High-active: In the active mode +24 V are internally applied to output M+:

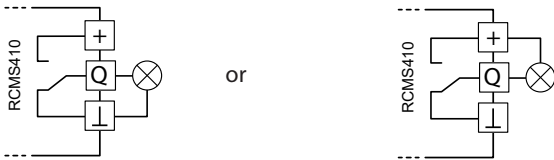

Low-active: In the active mode the GND potential is applied to output Q.

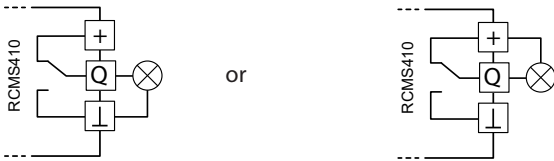

In the passive mode an external voltage can be connected (see Technical data). The output switches the applied potential to GND.

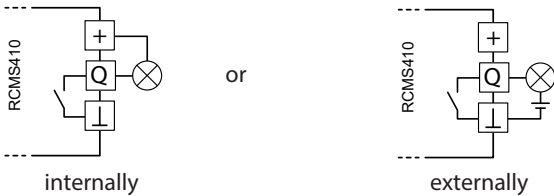

Permanently high: The output is permanently set to +24 V. In this manner e. g. an additional reference for the digital input can be created.

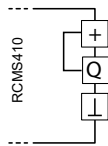

Permanently low: The output is permanently switched to GND. In this manner e. g. an additional reference for the digital input can be created.

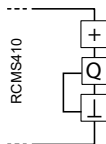

4.4 Digital input I

Settings in registers 32000...32001

The digital input "I" can read the status of a potential-free contact.

The digital input "I" can trigger either a test, a reset or the combined function T/R (register 32301). As with the test and reset function of the T/R-button, the combined function T/R is located at the front.

Example (high-active mode)

Closing the contact and opening it within 1...3 s.	Activates the reset function
Closing the contact and opening it within 3...6 s	Activates the test function
Closing the contact and not opening it again (faulty contact)	No function change. A faulty switch can be detected immediately!

i The NFC, address setting, and protect functions are not activated via this input.

The following settings can be assigned to input I:

High-active: Event is carried out, when the digital input undergoes a signal change from low to high.

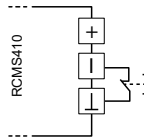

Low-active: Event is carried out, when the digital input undergoes a signal change from high to low.

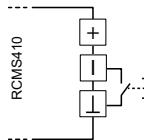

i The response delay and the delay on release of the digital input are set to 100 ms each.

4.5 Inputs CT1...4

4.5.1 Measuring-current-transformer connection

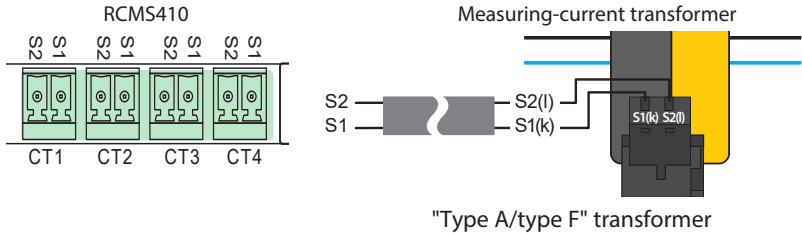

CAUTION!

When residual currents of high frequencies (>10 kHz) are present at one of the connected residual-current transformers, an over-reaction on all channels to which a CTUB102-CTBCxx is connected may be the result.

On these channels small response values may lead to nuisance tripping. Routing of the lines in accordance with the installation instructions for the transformers can minimise this effect.

i *Ensure that the measuring-current transformers are connected correctly. Terminal S1 must be connected to terminal "S1" (k) of the measuring-current transformer. Terminal S2 must be connected to terminal "S2" (l) of the measuring-current transformer.*

i *For further information on the connection of measuring-current transformers, refer to the corresponding manuals of the measuring-current transformers. The installation instructions specified there must be observed.*

i For UL applications:

The measuring current transformers must be connected to the monitor before operation is started.

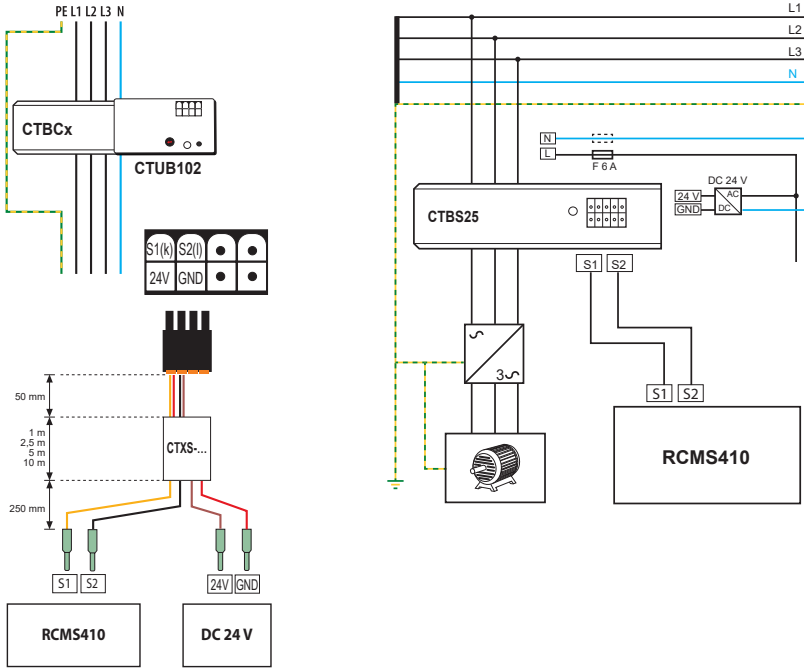

"Type B/type B+" transformer

Suitable measuring-current transformers

Type B/type B+		Type A/type F	Type A		
CTBS	CTUB series	CTAC series	Wx series	WR series	WS series
CTBS25	CTUB102	CTAC20	W0-S20	WR70x175S	WS20x30
		CTAC35	W1-S35	WR115x305S	WS50x80
		CTAC60	W2-S70	WR150x350S	WS50x80S
		CTAC120	W3-S105	WR200x500S	WS80x120
		CTAC210	W4-S140	WR70x175SP	WS80x80S
			W5-S210	WR115x305SP	WS80x120S
				WR150x350SP	WS80x160S
				WR200x500SP	

4.5.2 Connection of CTs of other manufacturers

External measuring current transformers can only be used when function module C is activated. The number of turns of the external transformer must be entered (registers 33104...33107).

Use residual current transformers and not load-current transformers.

Response range

The maximum response range is 6 mA ... 30 A. The actual upper limit of the response range depends on the number of turns n of the measuring-current transformer used:

$$\text{Upper limit of response range}_{\text{new}} = 30 \text{ A} \times n/600$$

Measuring range

The upper limit of the measuring range depends on the number of turns n of the measuring-current transformer used:

$$\text{Measuring range upper limit}_{\text{new}} = \text{measuring range indicated on the datasheet}^{1)} \times n/600$$

Continuous residual current

The **permissible continuous residual current** depends on the number of turns n of the measuring-current transformer used:

$$\text{permissible continuous residual current}_{\text{new}} = \text{permissible secondary current}^{1)} \times n$$

¹⁾ see chapter. "8.2 Tabular data"



Compliance with the respective product standard under „Standards & certifications“ cannot be ensured if an external transformer is used and, if necessary, needs to be assessed separately after consultation with the manufacturer.

4.5.3 CT1...4 as digital input

Settings in registers 32300...32301

The inputs CT1...4 can alternatively also be used as digital inputs. In this event, the following technical conditions must be met:

- The values of a potential-free contact are read in.
- < 10 Ω: open;
- > 100 Ω: closed;
- Current via switching contact: 0.6 mA.

The behaviour depends on the mode set (high-active or low-active):

- When the contact is closed with high-active: main alarm
- When the contact is opened with low-active: main alarm

With a main alarm the rms-value (min., max., and avg.) is output as 1, if there is no alarm as 0. For an alarm to be output correctly at the corresponding interfaces the corresponding RMS alarm assignment must be enabled.

4.6 RS-485 interface

Specification

The RCMS410 has an RS-485 interface with Modbus RTU protocol. In a system setup it is therefore compatible with other Modbus RTU-capable device series from Bender, such as e. g. the RCMB300 series, RCMS150-01, and RCMB13...-01. Up to 247 Modbus-RTU devices can be used on the bus.

The RS-485 specification restricts the cable length to 1200 m and requires a daisy chain connection.

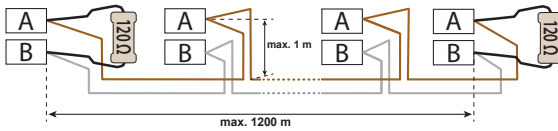

As bus cable a twisted-pair, shielded cable, shield on one side to PE, must be used. CAT6/CAT7 or J-Y(St)Y min. 2 x 0.8 are suitable.

i *If there are several devices with their own power supply units on the bus, protection against direct contact shall be ensured, as the maximum permissible total leakage current of 0.5 mA can be exceeded.*

Termination

The bus line must be terminated at both ends with resistors (120 Ω, > 0.25 W).

A terminating resistor is installed in the device and can be enabled or disabled with the DIP switch at the underside of the housing.

5 Operation and settings on the device

5.1 RCMS410 front panel (overview)

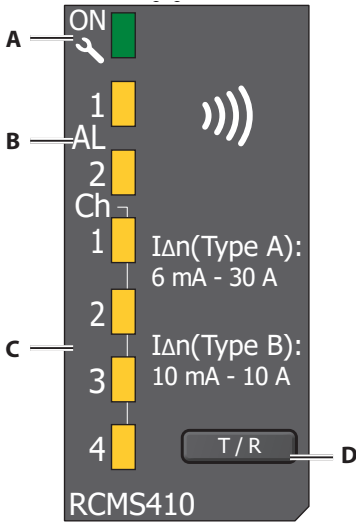

	Front panel
A	STATUS LED ON – operating modes
B	ALARM LEDs – AL1 (prewarning) / AL2 (main alarm)
C	LEDs – measuring-current transformer 1, 2, 3, 4
D	T/R BUTTON – Test/Reset

Fig. 5-6 RCMS410-24 front panel

5.2 STATUS LED

Multicoloured display of various operating modes.



LED	Operating mode
Green	START PHASE Device booting after start NORMAL OPERATION Device in fault-free state
Yellow, flashing	CT FAULT Connection fault of measuring-current transformer, LED flashes in time with the LED of the respective faulty CT.
Red	DEVICE ERROR Restart or replacement of the device required.
Blue, flashing (frequency approx. 2 s)	NFC ACTIVE

5.3 ALARM LEDs

Display of prewarning AL1 and main alarm AL2.

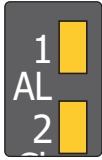

LED	Operating state
AL1	PREWARNING Lights up continuously when the prewarning threshold has been exceeded on a channel.
AL2	MAIN ALARM Flashes when the residual-operating-current threshold $I_{\Delta n}$ has been exceeded on a channel.

5.4 CHANNEL-INDICATION LEDs

Channel indication in relation to the residual operating current $I_{\Delta n}$

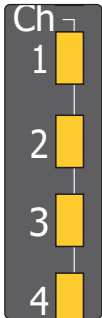

LED	Operating state
Ch 1	Measuring channel LED: • Lights up continuously when the prewarning threshold has been exceeded.
Ch 2	• Flashes in time with the AL2 LED when the residual-operating-current threshold $I_{\Delta n}$ has been exceeded or when it is used as a digital input and there is a main alarm.
Ch 3	• Flashes in time with the STATUS LED when a measuring-current-transformer connection fault is present at the corresponding channel.
Ch 4	

5.5 T/R BUTTON

The T/R button activates different operating modes depending on how long it is pressed.



Mode	Operating time	STATUS LED
Reset	1...3 s	flashes yellow
TEST	3...6 s	flashes red
NFC	6...10 s	flashes blue
ADDR	10...15 s	flashes green
PROTECT	20...25 s	flashes violet

Overview

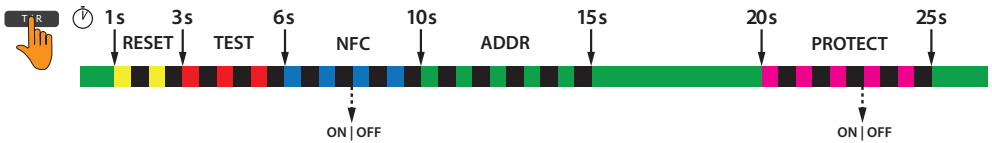

5.5.1 "RESET" function

The "RESET" function on the button resets stored alarm states.

5.5.2 "TEST" function

The "TEST" function simulates a residual current of $1.5 \times I_{\Delta n}$ for a period of 5 seconds. During this period, the device has the following states:

- Display of the alarm value via the LEDs and the interface.
- The test status can be read out via the interface:
 - 0 = no test
 - 1 = internal test
 - 2 = external test (interface)
- For the duration of the test t_{on} and t_{off} are set to 0 s.

5.5.3 "NFC" function

The "NFC" function changes the current activation status of the NFC interface, when the T/R button is pressed and held for a period of 6...10 s.

The NFC interface disables automatically within 5 minutes, in case it has not been disabled manually before.



5.5.4 "ADDR" function

The "ADDR" function switches the device to address setting mode for the RS-485 address. The channel indication LEDs and the status LED indicate the device's address.

How to enter an address:

1. Press and hold the T/R button until status LED flashes green (10...15 s).
 - After the T/R button is released, the status LED lights red.
2. Set **HUNDREDS** digit. Press T/R button briefly until the desired value appears. Press and hold T/R button once (> 2 s) to confirm.
 - After the T/R button is released, the status LED lights green.
3. Set **TENS** digit. Press T/R button briefly until the desired value appears. Press and hold T/R button once (> 2 s) to confirm.
 - After the T/R button is released, the status LED lights blue.

4. **Set UNITS** digit. Press T/R button briefly until the desired value appears. Press and hold T/R button once (> 2 s) to confirm.
5. To exit the address setting mode, press and hold T/R button once (2 s).
 - After the T/R button is released, the status LED lights green.

The address values are displayed via BCD code.

Addresses can only be entered within the valid address range. When there is no input for a period of 5 minutes, the device automatically exits the address setting mode. The device then uses the currently set Modbus address.

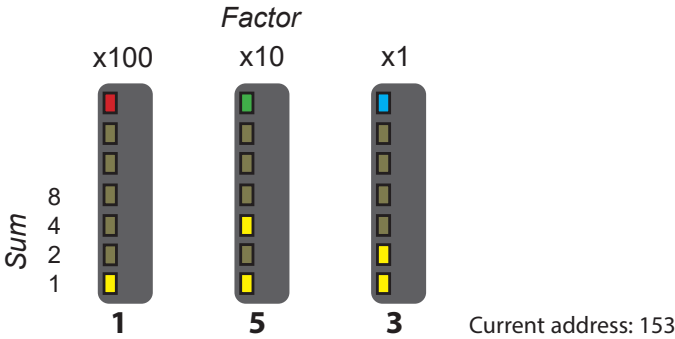

5.5.5 "PROTECT" function

The "PROTECT" function on the T/R button locks or enables write access to the Modbus registers of the individual parameters. Modbus register 32007 "Write access" can only lock write access but cannot enable it.

- When the T/R button is activated for at least 20 seconds, the status LED changes from continuously green to flashing violet and remains like this for the next 5 seconds when the button continues to be pressed.
- When the T/R button is released while the status LED is flashing violet, the activation state of the Modbus register "Write access" switches from the current selection of the two possible states to the other state, i. e. from "enabled" to "locked" or vice versa.

5.6 Harmonic analysis

The 1st ...20th harmonic are continuously calculated for each channel (registers 4000...4079). In addition, the corresponding THD value is continuously calculated (registers 4080...4087). These values can therefore be read out at any moment.

The full range from the 1st to the 400th harmonic and the corresponding THD value are only calculated upon request for a defined channel. The calculation takes approx. 2 s.

For the calculations to start, the number of the channel for which the calculation is to be performed must be written in register 4096. Once a "1" is output in register 4097, the calculation is completed and the values of the 1st ...400th harmonic are available in registers 4098...4448, the THD value in register 4498.

6 Modbus interface

6.1 Overview

Description of the Modbus registers for RCMS41x devices. The following Modbus function codes are supported:

- Holding registers for reading out values
(Read Holding Register; function code 0x03)
- Registers for device programming
(Write Multiple Registers; function code 0x10)

For a complete Modbus-protocol specification, visit <http://www.modbus.org>.

6.2 Read and write permissions

RO	Read Only (read access only)
RW	Read/Write (read and write access)
WO	Write Only (write access only)

6.3 Data types

Float	IEEE754 32-bit (single precision floating point number)	4 bytes
INT16	Signed 16-bit integer	2 bytes
INT32	Signed 32-bit integer	4 bytes
UINT8	Unsigned 8-bit integer	1 byte (shown as 2 bytes)
UINT16	Unsigned 16-bit integer	2 bytes
UINT32	Unsigned 32-bit integer	4 bytes
String UTF8	ASCII character string	

6.4 Register ranges

Range	Start address	End address
Info	0	998
Alarm and measuring values	999	1999
Monitoring functions	2000	2999
Status information	3000	3999
Harmonic analysis	4000	4500
Modbus RTU parameters	32000	32099
Input "I"	32300	32399
Input/output "Q"	32400	32499
Output "M+"	32500	32599

Range	Start address	End address
Response values	32600	32699
Function/response behaviour	32700	32799
Alarm behaviour	32800	32899
Time response	32900	32999
Monitoring functions	33000	33010
Measuring-current transformer	33100	33110
Device error codes	58000	58999
Control commands	59000	59010
Function-control commands	60000	60003

6.5 Device-information registers

Register	Description	Format	Bytes	Prop-erty	Value/Unit/Comment
Device information (registers 0...998)					
0	Device name	String UTF8	32	RO	e.g.: RCMS410-24
16	Article number	String UTF8	32	RO	e.g.: B74604040
32	Serial number	String UTF8	32	RO	10 characters, e. g.: 2002123456
48	Manufacturer	String UTF8	32	RO	Bender GmbH & Co. KG
64	Application D number	UINT16	2	RO	631 = D631
65	Application version number	UINT16	2	RO	xxx = Vx.xx
66	Application build number	UINT16	2	RO	Build#
67	Boot loader D number	UINT16	2	RO	632 = D632
68	Bootloader version number	UINT16	2	RO	xxx = Vx.xx
69	Boot loader build number	UINT16	2	RO	Build#
70	Device status	UINT16	2	RO	Bit 0 (LSB): NFC with 0 = disabled, 1 = enabled Bit 1...15: 0 (reserved)
71	Device characteristics	UINT16	2	RO	Bit 0 (LSB): Alarm-indicator relays CH1 and CH2 available Bit 1: Harmonic analysis available Bit 2: CT "type B/type B+" can be used Bit 3: External transformer ("Type A" only) can be used Bit 4: History memory can be used Bit 5...15: 0 (reserved) with 0 = no, 1 = yes

6.6 Alarm/measuring value registers

Register	Description	Format	Bytes	Property	Value/Unit/Comment	
Measured values (registers 999...1999)						
999	Number of active messages	UINT16	2	RO	0...n = number of active messages (device error, alarms, connection faults, ...) n is the number of messages that could also be attributed to an output (e.g. relay)	
1000	Max. residual-current measured value	AC CH1	UINT8	8	RO	Measured-value block: In each case the max. measured value incl. corresponding alarm and measuring-range states since the last Modbus query is output. Size of the measured-value block: 4 x UINT8 = 8
1004		AC CH2	UINT8	8	RO	
1008		AC CH3	UINT8	8	RO	
1012		AC CH4	UINT8	8	RO	
1016		DC CH1	UINT8	8	RO	Content of the measured-value block: <ul style="list-style-type: none"> • Adr. Offset 0 (e.g. 1000): measured value, part 1 [Float32_t] • Adr. Offset 1 (e.g. 1001): measured value, part 2 [Float32_t] • Adr. Offset 2 (e.g. 1002): alarm status <ul style="list-style-type: none"> 0: no alarm 1: prewarning 2: main alarm • Adr. Offset 3 (e.g. 1003): measuring range <ul style="list-style-type: none"> 0: "=" 1: "<" 2: ">"
1020		DC CH2	UINT8	8	RO	
1024		DC CH3	UINT8	8	RO	
1028		DC CH4	UINT8	8	RO	
1032		RMS CH1	UINT8	8	RO	
1036		RMS CH2	UINT8	8	RO	
1040		RMS CH3	UINT8	8	RO	
1044	RMS CH2	UINT8	8	RO		
1048	Current value of residual current	AC CH1	Float	4	RO	Currently measured value
1050		AC CH2	Float	4	RO	
1052		AC CH3	Float	4	RO	
1054		AC CH4	Float	4	RO	
1056		DC CH1	Float	4	RO	
1058		DC CH2	Float	4	RO	
1060		DC CH3	Float	4	RO	
1062		DC CH4	Float	4	RO	
1064		RMS CH1	Float	4	RO	
1066		RMS CH2	Float	4	RO	
1068		RMS CH3	Float	4	RO	
1070		RMS CH2	Float	4	RO	

Register	Description	Format	Bytes	Property	Value/Unit/Comment	
1072	Min. residual-current measured value	AC CH1	Float	4	RO	
1074		AC CH2	Float	4	RO	
1076		AC CH3	Float	4	RO	
1078		AC CH4	Float	4	RO	
1080		DC CH1	Float	4	RO	
1082		DC CH2	Float	4	RO	
1084		DC CH3	Float	4	RO	
1086		DC CH4	Float	4	RO	
1088		RMS CH1	Float	4	RO	
1090		RMS CH2	Float	4	RO	
1092		RMS CH3	Float	4	RO	
1094		RMS CH2	Float	4	RO	
1096		Residual current average	AC CH1	Float	4	RO
1098			AC CH2	Float	4	RO
1100	AC CH3		Float	4	RO	
1102	AC CH4		Float	4	RO	
1104	DC CH1		Float	4	RO	
1106	DC CH2		Float	4	RO	
1108	DC CH3		Float	4	RO	
1110	DC CH4		Float	4	RO	
1112	RMS CH1		Float	4	RO	
1114	RMS CH2		Float	4	RO	
1116	RMS CH3		Float	4	RO	
1118	RMS CH2		Float	4	RO	

Smallest measured value since the last Modbus query

Measured-value arithmetic mean since the last Modbus query

6.7 Monitoring-functions registers

Register	Description	Format	Bytes	Prop-erty	Value/Unit/Comment	
Monitoring functions (registers 2000...2050)						
2000	CT status	CT1	UINT16	2	RO	0 = OK 1 = short circuit 2 = interruption
2001		CT2	UINT16	2	RO	
2002		CT3	UINT16	2	RO	
2003		CT4	UINT16	2	RO	
2014	Reload memory of input/output "Q"	UINT16	2	RO	0 = Reload memory disabled 1 = Reload memory enabled	
2015	Reload memory of output "M+."	UINT16	2	RO		

6.8 Status-information registers

Register	Description	Format	Bytes	Prop-erty	Value/Unit/Comment
Status information (registers 3000...3999)					
3000	Test status	UINT16	2	RO	0 = no active test 1 = test active via T/R button 2 = test active via interface
3001	Status of input "I"	UINT16	2	RO	0 = input is not operated 1 = input is operated
3002	Status of input/output "Q"	UINT16	2	RO	0 = input is not operated 1 = input is operated 2 = input /output "Q" is configured as output
3005	Status of output "Q"	UINT16	2	RO	Current output status: 0 = output disabled (none of the alarm-assignment events occurred) 1 = output enabled (at least one of the alarm-assignment events occurred)
3006	Status of output "M+."	UINT16	2	RO	
3009	Memory status enabled input/output "Q"	UINT16	2	RO	The last enabled status (1) of the output will be retained until the next Modbus query is made
3010	Memory status enabled output "M+."	UINT16	2	RO	
3013	Memory status disabled input/output "Q"	UINT16	2	RO	The last disabled status (0) of the output will be retained until the next Modbus query is made
3014	Memory status disabled output "M+."	UINT16	2	RO	

6.9 Harmonic-analysis registers

Registers (4000...4500) are only available with the optional function module A "harmonic analysis". Otherwise these registers are reserved.

Register	Description	Format	Bytes	Prop-erty	Value/Unit/Comment
Harmonic analysis, individual values H1...20 (registers 4000...4079)					
4000	H1, CH1	UINT16	2	RO	1st harmonic [mA]
4001	H2, CH1	UINT16	2	RO	2nd harmonic [mA]
4002	H3, CH1	UINT16	2	RO	3rd harmonic [mA]
4003	H4, CH1	UINT16	2	RO	4th harmonic [mA]
4004	H5, CH1	UINT16	2	RO	5th harmonic [mA]
4005	H6, CH1	UINT16	2	RO	6th harmonic [mA]
4006	H7, CH1	UINT16	2	RO	7th harmonic [mA]
4007	H8, CH1	UINT16	2	RO	8th harmonic [mA]
4008	H9, CH1	UINT16	2	RO	9th harmonic [mA]
4009	H10, CH1	UINT16	2	RO	10th harmonic [mA]
4010	H11, CH1	UINT16	2	RO	11th harmonic [mA]
4011	H12, CH1	UINT16	2	RO	12th harmonic [mA]
4012	H13, CH1	UINT16	2	RO	13th harmonic [mA]
4013	H14, CH1	UINT16	2	RO	14th harmonic [mA]
4014	H15, CH1	UINT16	2	RO	15th harmonic [mA]
4015	H16, CH1	UINT16	2	RO	16th harmonic [mA]
4016	H17, CH1	UINT16	2	RO	17th harmonic [mA]
4017	H18, CH1	UINT16	2	RO	18th harmonic [mA]
4018	H19, CH1	UINT16	2	RO	19th harmonic [mA]
4019	H20, CH1	UINT16	2	RO	20th harmonic [mA]

Measuring channel 1

Register	Description	Format	Bytes	Property	Value/Unit/Comment
4020	H1, CH2	UINT16	2	RO	1st harmonic [mA]
4021	H2, CH2	UINT16	2	RO	2nd harmonic [mA]
4022	H3, CH2	UINT16	2	RO	3rd harmonic [mA]
4023	H4, CH2	UINT16	2	RO	4th harmonic [mA]
4024	H5, CH2	UINT16	2	RO	5th harmonic [mA]
4025	H6, CH2	UINT16	2	RO	6th harmonic [mA]
4026	H7, CH2	UINT16	2	RO	7th harmonic [mA]
4027	H8, CH2	UINT16	2	RO	8th harmonic [mA]
4028	H9, CH2	UINT16	2	RO	9th harmonic [mA]
4029	H10, CH2	UINT16	2	RO	10th harmonic [mA]
4030	H11, CH2	UINT16	2	RO	11th harmonic [mA]
4031	H12, CH2	UINT16	2	RO	12th harmonic [mA]
4032	H13, CH2	UINT16	2	RO	13th harmonic [mA]
4033	H14, CH2	UINT16	2	RO	14th harmonic [mA]
4034	H15, CH2	UINT16	2	RO	15th harmonic [mA]
4035	H16, CH2	UINT16	2	RO	16th harmonic [mA]
4036	H17, CH2	UINT16	2	RO	17th harmonic [mA]
4037	H18, CH2	UINT16	2	RO	18th harmonic [mA]
4038	H19, CH2	UINT16	2	RO	19th harmonic [mA]
4039	H20, CH2	UINT16	2	RO	20th harmonic [mA]

Measuring channel 2

Register	Description	Format	Bytes	Property	Value/Unit/Comment
4040	H1, CH3	UINT16	2	RO	1st harmonic [mA]
4041	H2, CH3	UINT16	2	RO	2nd harmonic [mA]
4042	H3, CH3	UINT16	2	RO	3rd harmonic [mA]
4043	H4, CH3	UINT16	2	RO	4th harmonic [mA]
4044	H5, CH3	UINT16	2	RO	5th harmonic [mA]
4045	H6, CH3	UINT16	2	RO	6th harmonic [mA]
4046	H7, CH3	UINT16	2	RO	7th harmonic [mA]
4047	H8, CH3	UINT16	2	RO	8th harmonic [mA]
4048	H9, CH3	UINT16	2	RO	9th harmonic [mA]
4049	H10, CH3	UINT16	2	RO	10th harmonic [mA]
4050	H11, CH3	UINT16	2	RO	11th harmonic [mA]
4051	H12, CH3	UINT16	2	RO	12th harmonic [mA]
4052	H13, CH3	UINT16	2	RO	13th harmonic [mA]
4053	H14, CH3	UINT16	2	RO	14th harmonic [mA]
4054	H15, CH3	UINT16	2	RO	15th harmonic [mA]
4055	H16, CH3	UINT16	2	RO	16th harmonic [mA]
4056	H17, CH3	UINT16	2	RO	17th harmonic [mA]
4057	H18, CH3	UINT16	2	RO	18th harmonic [mA]
4058	H19, CH3	UINT16	2	RO	19th harmonic [mA]
4059	H20, CH3	UINT16	2	RO	20th harmonic [mA]

Measuring channel 3

Register	Description	Format	Bytes	Property	Value/Unit/Comment
4060	H1, CH4	UINT16	2	RO	1st harmonic [mA]
4061	H2, CH4	UINT16	2	RO	2nd harmonic [mA]
4062	H3, CH4	UINT16	2	RO	3rd harmonic [mA]
4063	H4, CH4	UINT16	2	RO	4th harmonic [mA]
4064	H5, CH4	UINT16	2	RO	5th harmonic [mA]
4065	H6, CH4	UINT16	2	RO	6th harmonic [mA]
4066	H7, CH4	UINT16	2	RO	7th harmonic [mA]
4067	H8, CH4	UINT16	2	RO	8th harmonic [mA]
4068	H9, CH4	UINT16	2	RO	9th harmonic [mA]
4069	H10, CH4	UINT16	2	RO	10th harmonic [mA]
4070	H11, CH4	UINT16	2	RO	11th harmonic [mA]
4071	H12, CH4	UINT16	2	RO	12th harmonic [mA]
4072	H13, CH4	UINT16	2	RO	13th harmonic [mA]
4073	H14, CH4	UINT16	2	RO	14th harmonic [mA]
4074	H15, CH4	UINT16	2	RO	15th harmonic [mA]
4075	H16, CH4	UINT16	2	RO	16th harmonic [mA]
4076	H17, CH4	UINT16	2	RO	17th harmonic [mA]
4077	H18, CH4	UINT16	2	RO	18th harmonic [mA]
4078	H19, CH4	UINT16	2	RO	19th harmonic [mA]
4079	H20, CH4	UINT16	2	RO	20th harmonic [mA]

Measuring channel 4

6.10 THD, RMS registers, H1...400

Register	Description	Format	Bytes	Prop-erty	Value/Unit/Comment
Harmonic analysis H1...400 (registers 4080...4500)					
4080	THD CH1	UINT16	2	RO	Total of all harmonics (incl. fundamental harmonic) divided by fundamental harmonic; value range: 0...10000 [%]
4081	THD validity CH1	UINT16	2	RO	Validity of THD value; 0 = -, 2: >
4082	THD CH2	UINT16	2	RO	Total of all harmonics (incl. fundamental harmonic) divided by fundamental harmonic; value range: 0...10000 [%]
4083	THD validity CH2	UINT16	2	RO	Validity of THD value; 0 = -, 2: >
4084	THD CH3	UINT16	2	RO	Total of all harmonics (incl. fundamental harmonic) divided by fundamental harmonic; value range: 0...10000 [%]
4085	THD validity CH3	UINT16	2	RO	Validity of THD value; 0 = -, 2: >
4086	THD CH4	UINT16	2	RO	Total of all harmonics (incl. fundamental harmonic) divided by fundamental harmonic; value range: 0...10000 [%]
4087	THD validity CH4	UINT16	2	RO	Validity of THD value; 0 = -, 2: >
4088... 4094	Reserved				
4096	Request calculation of full range	UINT16	2	RW	1 = measuring channel 1 2 = measuring channel 2 3 = measuring channel 3 4 = measuring channel 4
4097	Status of full-range calculation	UINT16	2	RO	0 = calculation ongoing or no calculation requested 1 = calculation completed
4098	H1...50	UINT16	100	RO	1st - 50th harmonic [mA] of the selected measuring channel
4148	H51...100	UINT16	100	RO	51st - 100th harmonic [mA] of the selected measuring channel
4198	H101...150	UINT16	100	RO	101st - 150th harmonic [mA] of the selected measuring channel
4248	H151...200	UINT16	100	RO	151st - 200th harmonic [mA] of the selected measuring channel
4298	H201...250	UINT16	100	RO	201st - 250th harmonic [mA] of the selected measuring channel
4348	H251...300	UINT16	100	RO	251st - 300th harmonic [mA] of the selected measuring channel
4398	H301...350	UINT16	100	RO	301st - 350th harmonic [mA] of the selected measuring channel
4448	H351...400	UINT16	100	RO	351st - 400th harmonic [mA] of the selected measuring channel
4498	THD full range	UINT16	2	RO	Total of all harmonics (incl. fundamental harmonic) divided by fundamental harmonic; value range: 0...10000 [%]
4499	Validity of full-range THD	UINT16	2	RO	Validity of THD value; 0 = -, 2: >

6.11 Modbus-parameter registers

Register	Description	Format	Bytes	Prop-erty	Value/Unit/Comment	Factory setting
Modbus RTU parameters (register 32000)						
32000	Device address	UINT16	2	RW	1...247	Last 2 digits of the serial number + 100
32001	Baud rate	UINT32	4	RW	9600, 19200, 38400, 57600, 115200	19200
32003	Parity	UINT16	2	RW	1 = even 2 = odd 3 = none	1
32004	Stop bits	UINT16	2	RW	1 = 1 2 = 2 3 = automatic	3
32006	Allow update	UINT16	2	RW	0 = do not allow SW-update via Modbus RTU 1 = allow SW-update via Modbus RTU	0
32007	Write access	UINT16	2	RW	1: Enable write access (parameters can be changed) 2: Write access disabled (parameters can only be read)  <i>Note: Access can only be enabled directly at the device via T/R button!</i>	1

6.12 Registers of digital input "I"

Register	Description	Format	Bytes	Prop-erty	Value/Unit/Comment	Factory setting
Parameters of input "I" (32300)						
32300	Mode	UINT16	2	RW	1 = high-active 2 = low-active	2
32301	Function	UINT16	2	RW	1 = none 2 = reset 3 = test 4 = T/R (test/reset combined)	3

6.13 Registers of input/output "Q"

Register	Description	Format	Bytes	Property	Value/Unit/Comment	Factory setting
Parameters of input/ output "Q" (32400)						
32400	Mode	UINT16	2	RW	1 = output: passive 2 = output: high-active 3 = output: low-active 4 = output: permanently high 5 = output: permanently low 6 = input: high-active 7 = input: low-active	3
32401	Function	UINT16	2	RW	0 = none Available with modes 6...7: 1 = reset 2 = test Available with modes 1...3: 3 = prewarning 4 = main alarm	4
32402	Test	UINT16	2	RW	0 = disabled	1
32403	Device-error alarm assignment	UINT16	2	RW	1 = enabled	1
32404	AC CT1 alarm assignment	UINT16	2	RW	0 = disabled	1
32405	AC CT2 alarm assignment	UINT16	2	RW		1 = enabled
32406	AC CT3 alarm assignment	UINT16	2	RW	0 = disabled	1
32407	AC CT4 alarm assignment	UINT16	2	RW		1 = enabled
32408	DC CT1 alarm assignment	UINT16	2	RW	0 = disabled	1
32409	DC CT2 alarm assignment	UINT16	2	RW		1 = enabled
32410	DC CT3 alarm assignment	UINT16	2	RW	0 = disabled	1
32411	DC CT4 alarm assignment	UINT16	2	RW		1 = enabled
32412	RMS CT1 alarm assignment	UINT16	2	RW	0 = disabled	1
32413	RMS CT2 alarm assignment	UINT16	2	RW		1 = enabled
32414	RMS CT3 alarm assignment	UINT16	2	RW	0 = disabled	1
32415	RMS CT4 alarm assignment	UINT16	2	RW		1 = enabled
32416	Connection-fault alarm assignment CT1...4	UINT16	2	RW	0 = disabled 1 = enabled	1
32417	Measuring-channels-overloading alarm assignment	UINT16	2	RW	0 = disabled 1 = enabled	1
32418	Reload cycles	UINT16	2	RW	0...10 = Number of switching cycles until the output status is frozen	0
32419	Reload time	UINT16	2	RW	2...60 [s] = time until reload counter will be reset	6

6.14 Registers of output "M+"

Register	Description	Format	Bytes	Property	Value/Unit/Comment	Factory setting
Parameters of output "M+" (32500)						
32500	Mode	UINT16	2	RW	1 = output: passive 2 = output: high-active 3 = output: low-active 4 = output: permanently high 5 = output: permanently low 6 = output: 0...20 mA 7 = output: 4...20 mA 8 = output: 0...10 V 9 = output: 2...10 V	3
32501	Function	UINT16	2	RW	0 = none Operative with modes 1...3: 1 = prewarning 2 = main alarm Operative with modes 6...9: 3 = channel 1 (RMS) 4 = channel 2 (RMS) 5 = channel 3 (RMS) 6 = channel 4 (RMS)	2
32502	Linearity	UINT16	2	RW	Operative with functions 3...6: 1 = linear with respect to maximum scale value (see register 32503) 2 = linear with respect to 100 % of $I_{Dn\ RMS}$	2
32503	Scaling	UINT16	2	RW	Operative only with linearity 1: 0...65000 [mA], increment 1 mA, maximum scale value  Note: This value can be set to max. 5 x $I_{Dn\ RMS}$!	0
32504	Test	UINT16	2	RW	0 = disabled 1 = enabled	1
32505	Device-error alarm assignment	UINT16	2	RW	0 = disabled 1 = enabled	1
32506	AC CT1 alarm assignment	UINT16	2	RW	0 = disabled 1 = enabled	1
32507	AC CT2 alarm assignment	UINT16	2	RW		1
32508	AC CT3 alarm assignment	UINT16	2	RW		1
32509	AC CT4 alarm assignment	UINT16	2	RW		1
32510	DC CT1 alarm assignment	UINT16	2	RW	0 = disabled 1 = enabled	1
32511	DC CT2 alarm assignment	UINT16	2	RW		1
32512	DC CT3 alarm assignment	UINT16	2	RW		1
32513	DC CT4 alarm assignment	UINT16	2	RW		1
32514	RMS CT1 alarm assignment	UINT16	2	RW		1
32515	RMS CT2 alarm assignment	UINT16	2	RW		1
32516	RMS CT3 alarm assignment	UINT16	2	RW		1
32517	RMS CT4 alarm assignment	UINT16	2	RW		1

Register	Description	Format	Bytes	Property	Value/Unit/Comment	Factory setting
32518	Alarm assignment, CT-connection fault	UINT16	2	RW	0 = disabled 1 = enabled	1
32519	Measuring-channels-overloading alarm assignment	UINT16	2	RW	0 = disabled 1 = enabled	1
32520	Reload cycles	UINT16	2	RW	0...10 = Number of switching cycles until the output status is frozen	0
32521	Reload time	UINT16	2	RW	2...60 [s] = time until reload counter will be reset	6

6.15 Registers of response-value parameters

Register	Description	Format	Bytes	Property	Value/Unit/Comment	Factory setting	
Response-value parameters (32600)							
32600	Residual operating current $I_{\Delta n}$ AC CT1	Float	4	RW	enabled only with "type B"/"type B+" current transformers	0.03	
32602	$I_{\Delta n}$ AC CT2	Float	4	RW	0.010...10 [A] increment 0.001	0.03	
32604	$I_{\Delta n}$ AC CT3	Float	4	RW	i When "type B/type B+" current transformers are used: If no separate AC and DC response values are set, the response values shall be set to the same value as the RMS response value (reg. 32616...32622).	0.03	
32606	$I_{\Delta n}$ AC CT4	Float	4	RW		0.03	
32608	$I_{\Delta n}$ DC CT1	Float	4	RW		0.03	
32610	$I_{\Delta n}$ DC CT2	Float	4	RW		0.03	
32612	$I_{\Delta n}$ DC CT3	Float	4	RW		0.03	
32614	$I_{\Delta n}$ DC CT4	Float	4	RW		0.03	
32616	$I_{\Delta n}$ RMS CT1	Float	4	RW		for "type A" current transformers:	0.03
32618	$I_{\Delta n}$ RMS CT2	Float	4	RW		0.006...30 [A]; increment 0.001;	0.03
32620	$I_{\Delta n}$ RMS CT3	Float	4	RW	for "type B/type B+" current transformers:	0.03	
32622	$I_{\Delta n}$ RMS CT4	Float	4	RW	0.010...10 [A] increment 0.001	0.03	
32624	AC CT1 prewarning	UINT16	2	RW	with over-current function: 10...100 [%]; increment 1 with undercurrent function: 10...100 [%] (prewarning = register value + 100 = 110...200 [%]); increment 1 with window function: 10...100 [%]; increment 1	50	
32625	AC CT2 prewarning	UINT16	2	RW		50	
32626	AC CT3 prewarning	UINT16	2	RW		50	
32627	AC CT4 prewarning	UINT16	2	RW		50	
32628	DC CT1 prewarning	UINT16	2	RW		50	
32629	DC CT2 prewarning	UINT16	2	RW		50	
32630	DC CT3 prewarning	UINT16	2	RW		50	
32631	DC CT4 prewarning	UINT16	2	RW		50	
32632	RMS CT1 prewarning	UINT16	2	RW		50	
32633	RMS CT2 prewarning	UINT16	2	RW		50	
32634	RMS CT3 prewarning	UINT16	2	RW		50	
32635	RMS CT4 prewarning	UINT16	2	RW		50	

6.16 Function and operating-characteristics registers

Register	Description	Format	Bytes	Prop-erty	Value/Unit/Comment	Factory setting
Function and response behaviour parameters (32700...32720)						
32700	CT1 function	UINT16	2	RW	1 = overcurrent 2 = undercurrent 3 = window mode 4 = digital input: high-active 5 = digital input: low-active 6 = none	1
32701	CT2 function	UINT16	2	RW		1
32702	CT3 function	UINT16	2	RW		1
32703	CT4 function	UINT16	2	RW		1
32704	CT1 hysteresis	UINT16	2	RW	2...40 [%], increment 1 %	15
32705	CT2 hysteresis	UINT16	2	RW		15
32706	CT3 hysteresis	UINT16	2	RW		15
32707	CT4 hysteresis	UINT16	2	RW		15
32708	CT1 filter setting	UINT16	2	RW	1 = no filter 2 = type A 3 = type F 4 = type B 5 = type B+ 6 = 50 Hz 7 = 60 Hz 8 = 150 Hz 9 = 180 Hz 10 = 500 Hz 11 = 1000 Hz 12 = 2000 Hz 13 = 5000 Hz 14 = 10000 Hz	1
32709	CT2 filter setting	UINT16	2	RW		1
32710	CT3 filter setting	UINT16	2	RW		1
32711	CT4 filter setting	UINT16	2	RW		1
32712	Fundamental-harmonic frequency	UINT16	2	RW	50...1000 Hz; increment 1 Hz	50
32713	Preset factor	UINT16	2	RW	1...99; increment 1	3
32714	Preset offset	UINT16	2	RW	0...30000; increment 1 [mA]	30
32715	Automatic switching of CT1 measuring range	UINT16	2	RW	0 = disabled 1 = enabled i When this function is enabled, the release time t_{off} can increase by up to 2 s.	1
32716	Automatic switching of CT2 measuring range	UINT16	2	RW		1
32717	Automatic switching of CT3 measuring range	UINT16	2	RW		1
32718	Automatic switching of CT4 measuring range	UINT16	2	RW		1

6.17 Alarm-behaviour registers

Register	Description	Format	Bytes	Prop-erty	Value/Unit/Comment	Factory setting
Alarm behaviour parameters (32800 ... 32810)						
32800	CH1 fault memory	UINT16	2	RW	0 = disabled 1 = enabled	0
32801	CH2 fault memory	UINT16	2	RW		0
32802	CH3 fault memory	UINT16	2	RW		0
32803	CH4 fault memory	UINT16	2	RW		0
32804	CH1 starts in alarm status	UINT16	2	RW	0 = disabled 1 = enabled	0
32805	CH2 starts in alarm status	UINT16	2	RW		0
32806	CH3 starts in alarm status	UINT16	2	RW		0
32807	CH4 starts in alarm status	UINT16	2	RW		0

6.18 Time-behaviour registers

Register	Description	Format	Bytes	Prop-erty	Value/Unit/Comment	Factory setting
Time behaviour parameters (32900...32920)						
32900	Start-up delay t	Float	4	RW	0...999 [s], increment 1 ms	0
32902	Response delay t_{on} , CH1	Float	4	RW	0...10 [s], increment 1 ms	0
32904	Response delay t_{on} , CH2	Float	4	RW		0
32906	Response delay t_{on} , CH3	Float	4	RW		0
32908	Response delay t_{on} , CH4	Float	4	RW		0
32910	Delay on release t_{off} , CH1	Float	4	RW	0...999 [s], increment 1 ms	1
32912	Delay on release t_{off} , CH2	Float	4	RW		1
32914	Delay on release t_{off} , CH3	Float	4	RW		1
32916	Delay on release t_{off} , CH4	Float	4	RW		1

6.19 Monitoring-functions registers

Register	Description	Format	Bytes	Prop-erty	Value/Unit/Comment	Factory setting
Monitoring functions - parameters (33000)						
33000	CT-connection monitoring, CT1	UINT16	2	RW	0 = disabled 1 = enabled	1
33001	CT-connection monitoring, CT2	UINT16	2	RW		1
33002	CT-connection monitoring, CT3	UINT16	2	RW		1
33003	CT-connection monitoring, CT4	UINT16	2	RW		1

6.20 Measuring-current-transformer registers

Register	Description	Format	Bytes	Property	Value/Unit/Comment	Factory setting
CT - parameters (33100)						
33100	Type of measuring-current transformer, CT1	UINT16	2	RW	1 = "type A"/ "type F" 2 = "type B"/ "type B+"	1
33101	Type of measuring-current transformer, CT2	UINT16	2	RW		1
33102	Type of measuring-current transformer, CT3	UINT16	2	RW		1
33103	Type of measuring-current transformer, CT4	UINT16	2	RW		1
33104	Number of turns, CT1	UINT16	2	RW	i These registers can only be used, when the function module C "external current transformer connection" is enabled. If not, they are reserved. When an external current transformer is used, it is imperative that a turn number be selected. 100...1000; increment 1	-
33105	Number of turns, CT2	UINT16	2	RW		-
33106	Number of windings, CT3	UINT16	2	RW		-
33107	Number of windings, CT4	UINT16	2	RW		-

6.21 Device-error-code registers

i Register content 0 = no error

Register	Description	Format	Bytes	Property	Value/Unit/Comment	Reversible	Device faulty
Device error codes (58000)							
58000	Number of device errors	UINT16	2	RO	Number of active device errors	X	
58001	0.10	UINT16	2	RO	10 = CT-connection fault, CT1	X	
58002	0.11	UINT16	2	RO	11 = CT-connection fault, CT2	X	
58003	0.12	UINT16	2	RO	12 = CT-connection fault, CT3	X	
58004	0.13	UINT16	2	RO	13 = CT-connection fault, CT4	X	
58005	0.57	UINT16	2	RO	57 = connection fault at input/output "Q"	X	
58006	0.58	UINT16	2	RO	58 = connection fault at output "M+	X	
58007	3.21	UINT16	2	RO	321 = internal error		X
58008	3.25	UINT16	2	RO	325 = internal error		X
58009	4.70	UINT16	2	RO	470 = thermal overload at measuring inputs	X	
58010	4.71	UINT16	2	RO	471 = CT1 overload	X	
58011	4.72	UINT16	2	RO	472 = CT2 overload	X	
58012	4.73	UINT16	2	RO	473 = CT3 overload	X	
58013	4.74	UINT16	2	RO	474 = CT4 overload	X	

Register	Description	Format	Bytes	Property	Value/Unit/Comment	Reversible	Device faulty
58014	4.75	UINT16	2	RO	475 = invalid setting of CT1: AC, DC and/or RMS response values are too far apart	X	
58015	4.76	UINT16	2	RO	476 = invalid setting of CT2: AC, DC and/or RMS response values are too far apart	X	
58016	4.77	UINT16	2	RO	477 = invalid setting of CT3: AC, DC and/or RMS response values are too far apart	X	
58017	4.78	UINT16	2	RO	478 = invalid setting of CT4: AC, DC and/or RMS response values are too far apart	X	
58018	4.79	UINT16	2	RO	479 = invalid setting of CT1: "type B+" filter combined with a response value >300 mA	X	
58019	4.80	UINT16	2	RO	480 = invalid setting of CT2: "type B+" filter combined with a response value >300 mA	X	
58020	4.81	UINT16	2	RO	481 = invalid setting of CT3: "type B+" filter combined with a response value >300 mA	X	
58021	4.82	UINT16	2	RO	482 = invalid setting of CT4: "type B+" filter combined with a response value >300 mA	X	
58022	4.83	UINT16	2	RO	483 = invalid setting of CT1: AC response value <10 mA or >10 A with a "type B" measuring-current transformer	X	
58023	4.84	UINT16	2	RO	484 = invalid setting of CT2: AC response value <10 mA or >10 A with a "type B" measuring-current transformer	X	
58024	4.85	UINT16	2	RO	485 = invalid setting of CT3: AC response value <10 mA or >10 A with a "type B" measuring-current transformer	X	
58025	4.86	UINT16	2	RO	486 = invalid setting of CT4: AC response value <10 mA or >10 A with a "type B" measuring-current transformer	X	
58026	6.00	UINT16	2	RO	600 = internal error		X
58027	6.10	UINT16	2	RO	610 = internal error		X
58028	6.31	UINT16	2	RO	631 = internal error		X
58029	6.51	UINT16	2	RO	651 = internal error		X
58030	7.61	UINT16	2	RO	761 = internal error		X
58031	7.62	UINT16	2	RO	762 = internal error		X
58032	7.63	UINT16	2	RO	763 = internal error		X
58033	8.20	UINT16	2	RO	820 = internal error		X
58034	8.24	UINT16	2	RO	824 = T/R button defective	X	
58035	8.43	UINT16	2	RO	843 = internal error		X
58036	8.44	UINT16	2	RO	844 = internal error		X
58037	8.45	UINT16	2	RO	845 = internal error		X
58038	8.46	UINT16	2	RO	846 = internal error		X
58039	8.49	UINT16	2	RO	849 = internal error		X

6.22 Control-commands registers

Register	Description	Format	Bytes	Property	Value/Unit/Comment	Factory setting
Control commands (59000)						
59000	NFC	UINT16	2	RW	0 = disabled 1 = enabled (automatic disabling after 5 min)	0
59003	Start PRESET function	UINT16	2	WO	1 = start PRESET	N/A
59004	Start DC-offset fine matching	UINT16	2	WO	1...4 (corresponds to measuring channels CH1...4)	N/A

6.23 Function-control-commands registers

i Register 60000 (function-selection register) defines which function is enabled. Only specified values are permitted.

0 = find device via serial number

1 = set Modbus address

2 = find device

4 = reset to factory settings with/without interface parameters

6 = start test

7 = reset

Register	Description	Format	Bytes	Property	Value/Unit/Comment
Function-control commands (60000)					
Function 0: find device via serial number					
60000	Function selection	UINT16	2	WO	0 = selection of the function "Find device via serial number"
60001	Serial number	UINT32	4	WO	Serial number of the device to be found
60003	Period	UINT16	2	WO	0...300 [s] = time until the corresponding device lights up; 0 = end search function
Function 1: Set Modbus address					
60000	Function selection	UINT16	2	WO	1 = Selection of the function "set Modbus address"
60001	Serial number	UINT32	4	WO	Serial number of the device to be given a new modbus address. Only the device with the corresponding serial number will accept the new Modbus address.
60003	Modbus address	UINT16	2	WO	0...247 = new Modbus address
Function 2: find device					
60000	Function selection	UINT16	2	WO	2 = Selection of the "Find device" function
60001	Pattern value part 1	UINT16	2	WO	61918 Security pattern must be written for the function to be executed.

Register	Description	Format	Bytes	Property	Value/Unit/Comment
60002	Pattern value part 2	UINT16	2	WO	0 Security pattern must be written for the function to be executed.
60003	Period	UINT16	2	WO	0...300 [s] = time until the device lights up. When the device receives the value "0", the function is stopped.
Function 4: Reset to factory settings with/without interface parameters					
60000	Function selection	UINT16	2	WO	4 = Selection of the function "reset to factory settings with/without interface parameters"
60001	Pattern value part 1	UINT16	2	WO	64199 Security pattern must be written for the function to be executed.
60002	Pattern value part 2	UINT16	2	WO	1304 Security pattern must be written for the function to be executed.
60003	Reset type	UINT16	2	WO	1 = Reset all parameters to the factory settings 2 = Reset to factory settings without interface parameters
Function 6: start test					
60000	Function selection	UINT16	2	WO	6 = Selection of the function "start test"
60001	Pattern value part 1	UINT16	2	WO	32343 Security pattern must be written for the function to be executed.
60002	Pattern value part 2	UINT16	2	WO	0 Security pattern must be written for the function to be executed.
60003	Type of test	UINT16	2	WO	3 = Start RCM test
Function 7: reset					
60000	Function selection	UINT16	2	WO	7 = Selection of "Reset" function
60001	Pattern value part 1	UINT16	2	WO	13623 Security pattern must be written for the function to be executed
60002	Pattern value part 2	UINT16	2	WO	0 Security pattern must be written for the function to be executed.
60003	Reset type	UINT16	2	WO	1 = Reset of the alarm message when fault memory is enabled

7 Error – Cause – Error correction

Error pattern	Cause	Correction
Complete device		
No device start	Terminal blocks incorrectly plugged in	Plug in terminal blocks correctly
	Supply voltage incorrectly connected	Establish correct wiring
RS-485		
Instable communication	Missing termination due to incorrect commissioning or defective component. No device is terminated.	Configure the terminating resistor, determine the terminating resistor value and replace it if necessary.
	Faulty termination due to incorrect commissioning or defective component. Either only one or more than two devices have been terminated.	Configure the terminating resistor, check quality of the bus signal.
No communication	Incorrect configuration: different baud rates between bus devices.	Calibrate baud rates between all bus devices.
	Incorrect connection: terminals A and B are interchanged.	Establish correct bus wiring.
Inputs and outputs		
No level change	Incorrect configuration: Output configured as input	Check configuration
No level change	Incorrect connection: external connections	Check configuration
Enclosure		
Broken screw-mounting brackets	Device becomes detached due to broken mounting brackets.	Preventive measure: Use correct screw type and observe max. tightening torque. If the screw-mounting brackets are defective: mount on DIN rail or replace device.
Non-compliance with the insulation guideline	Insufficient insulation due to insufficient distance between mounting screws and connecting wires.	Use screws with plastic cover or mount on DIN rail.
Terminals		
Wires detach from the terminal	Due to splicing of wire ends, it is not possible to insert them into the terminal or fix them firmly in the terminal.	Use ferrules for mounting and connection to flexible cables.
Wires cannot be removed from terminal	Ferrules with strong crimp impressions get stuck in the terminal	Use correct crimping pliers for mounting and connection with flexible cables.

8 Technical data

8.1 Frequency responses of the filters

The curves represent the area in which the device triggers a main alarm.

i The frequency range below 15 Hz is not defined.

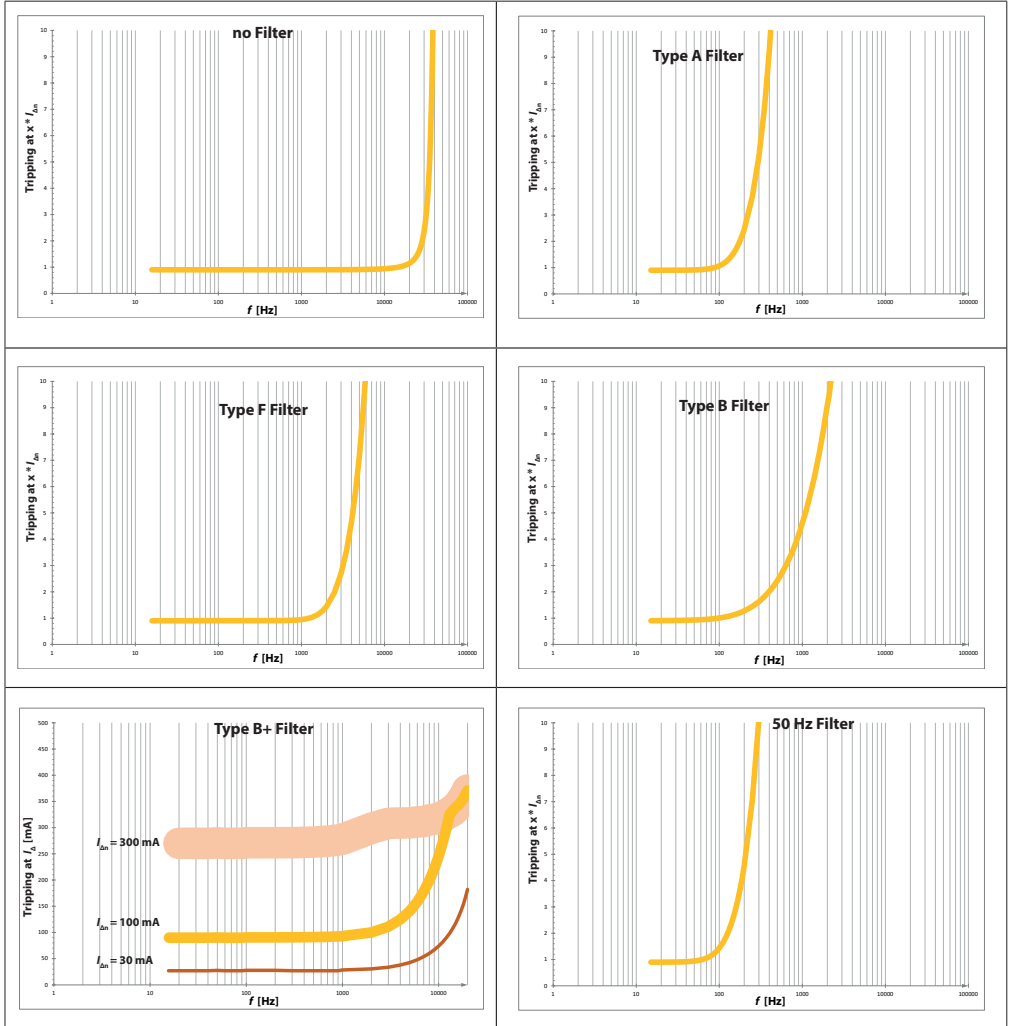

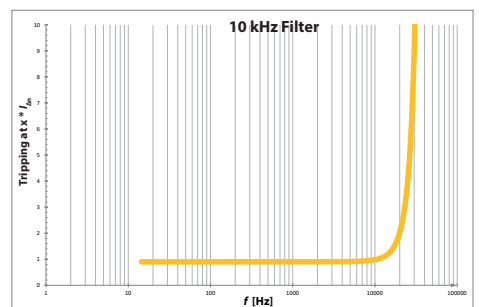
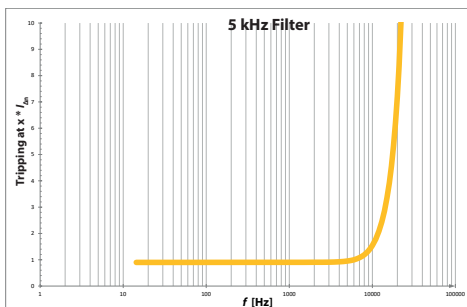
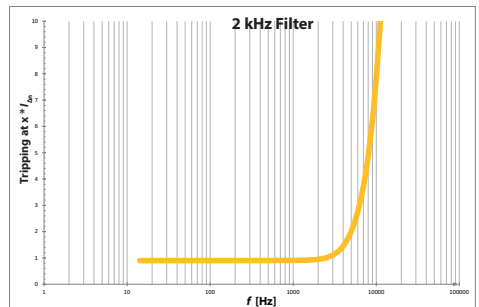
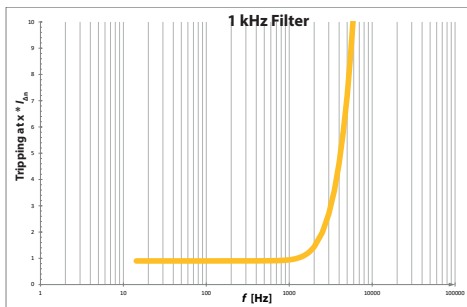
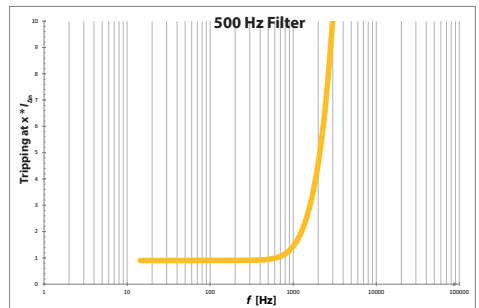
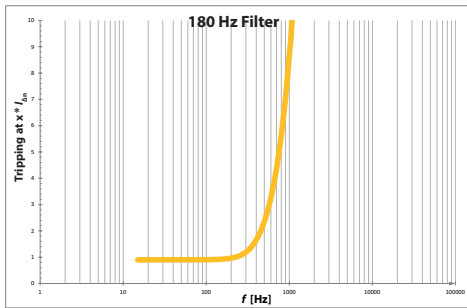
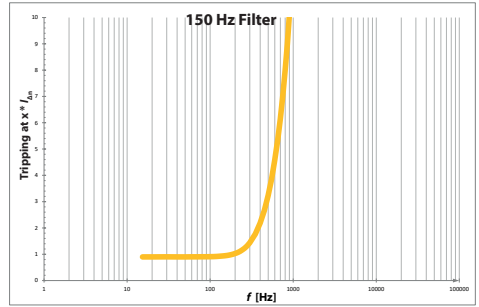
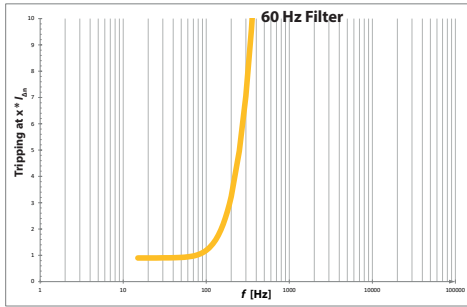

8.2 Tabular data

Insulation coordination (IEC 60664-1/IEC 60664-3)

Rated voltage	50 V
Overtoltage category	III
Rated impulse voltage.....	800 V
Rated insulation voltage.....	50 V
Pollution degree	2

Supply voltage

Connection	+, -
Supply voltage U_s	24 V DC
Protection class of power supply unit	2 or 3
Permissible tolerance	-30...+25 %
Permissible ripple	5 %
Power consumption.....	≤ 2 W
Inrush current (5 ms)	< 10 A

Measuring circuit

Burden (internal).....	33 Ω
Frequency range.....	DC, 15 Hz...20 kHz
for details	see chapter 8.1

Measuring range (peak)	3 mA...100 A
Measuring range rms.....	2 mA...70 A

Rated residual operating current

Type A, type F	30 A
Type B, type B+	10 A
Residual operating current I_{dn} (main alarm, AL2) ¹⁾	

Type A, type F	6 mA...30 A (30 mA)*
Type B, type B+	10 mA...10 A (30 mA)*
Prewarning (AL1)	10...100 % x I_{dn} (50 %)*
Operating uncertainty	±10 % (at 0.5...5 x I_{dn})
Relative response uncertainty.....	0...-20 %

for Lloyds applications

for railway applications as per	
EN 50121-3-2/-4 and EN 50155	0...-50 %
Hysteresis	10...25 % (15 %)*
Fault-memory alarm messages	on/off (off)*

permissible continuous residual current with

single-channel use.....	85 A
dual-channel use	60 A
use of three channels.....	49 A
use of four channels.....	42 A

Measuring-current transformers

Connection	of CT1, CT2, CT3, CT4
Measuring-current transformer series	
Type A	CTAC, CTAS, W, WR, WS
Type F	CTAC
Type B, type B+	CTUB-CTBC, CTBS
CT connection monitoring	yes

Rated voltage U_n

..... see measuring-current-transformer manual
Connecting wires

..... see measuring-current-transformer manual
For UL applications

External transformers

permissible continuous secondary current with.....	
single-channel use	140 A
dual-channel use	100 A
use of three channels	80 A
use of four channels	70 A
Permissible number of windings	100...1000

Time response

Start-up delay t_{start}	0...999 s (0 s)*
Response delay t_{on}	0...10 s (0 s)*
Delay on release t_{off}	0...999 s (1 s)*
Operating time t_{ae}	
with 1 x I_{dn}	≤250...ms
with 5 x I_{dn}	40...100 ms
Response time t_{an}	= $t_{ae} + t_{on}$
Recovery time t_b	≤ 500 ms
Response time for CT connection monitoring	
.....	≤ 10 s

Operation

Display.....status LED, alarm LEDs, channel LEDs
Buttons.....reset/test / NFC / address setting
Terminating resistor DIP switches

RS-485 interface

Connection	A, B
Protocol	Modbus RTU
Baud rate	max 115.2 kbits/s (19.2 kbits/s)*
Parity	even, no, odd (even)*
Stop bits	1/2/auto (auto)*
Cable length (at 9.6 kbits/s)	≤ 1200 m
Device address.....	1...247 (100+ last 2 digits of SN)*
Recommended lines, shield on one side connected to PE	
CAT6/CAT7	min AWG23
min. J-Y(St)Y 2 x 0.6 mm ²	twisted pair

NFC interface

Frequency	13.56 MHz
Transmitting power ²⁾	0 W

Input I

Connection	I, I _L
max. cable length (recommended)	10 m

external connections potential-free contact

Input/output Q

Connection Q, L
 max. cable length (recommended) 10 m
 max. load 20 mA
 Low voltage level (output) 0...2 V
 High voltage level (output) 10 V... U_5
 External voltage (passive mode).....DC 0...($U_5 - 1$ V)

Output M+

Connection M+, L
 max. cable length (recommended) 10 m
 max. load 20 mA
 Burden

current output $\leq 600 \Omega$
 voltage output $\geq 10 \text{ k}\Omega$

Tolerance with respect to final current/voltage value $\pm 20 \%$
 External voltage (passive mode).....DC 0... U_5

Connections

terminals plug-in screw-type terminals
 Terminal series ... Phoenix Contact MC 1,5/-ST-3,5 BK
 Connection properties

rigid 0.14 ... 1.5 mm²
 flexible, without plastic sleeve 0.25 ... 1.5 mm²
 flexible, with plastic sleeve 0.25 ... 0.5 mm²

Stripping length 7 mm
 Tightening torque 0.22... 0.25 Nm
 Conductor cross section AWG..... 28... 16

EMC/Environment

EMC DIN EN IEC 62020-1
 Operating temperature..... -40... +70 °C
 Transport -40... +85 °C
 Long-time storage -40... +70 °C
 Classification of climatic conditions acc. to IEC 60721
 (except condensation and formation of ice)

Stationary use (IEC 60721-3-3) 3K22
 Transport (IEC 60721-3-2) 2K11
 Long-term storage (IEC 60721-3-1) 1K22

Classification of mechanical conditions acc. to IEC 60721

Stationary use (IEC 60721-3-3) 3M11
 Transport (IEC 60721-3-2) 2M4
 Long-term storage (IEC 60721-3-1) 1M12

Other

Operating mode continuous operation
 Mounting vertical
 Degree of protection (DIN EN 60529)
 internal components IP30
 terminals IP20
 Enclosure material polycarbonate
 DIN rail mounting acc. to IEC 60715
 Flammability class UL94 V-0
 Weight < 65 g

* Factory setting

¹⁾ The requirements of the respective standards are only met with a response value from 30 mA to 9.9 A

²⁾ EMC influences may lead to communication interruptions at the NFC interface

8.3 Standards & certifications

The RCMS410 device has been developed in accordance with the following standards:

- DIN EN IEC 62020-1
- DIN EN 50155
- UL508

8.4 Licences

For a list of the open-source software used see our [homepage](#).

8.5 Declaration regarding the radio system

EU declaration of conformity

Bender GmbH & Co. KG hereby declares that the device covered by the Radio Equipment Directive complies with Directive 2014/53/EU. The full text of the EU Declaration of Conformity is available at the following internet address:

[EU declaration of conformity](#)

8.6 Ordering information

Type	Supply voltage U_s	Measuring-current transformers that can be used		Configurable at the factory	Enabled function modules *	Art. no.
		Type A Type F	Type B Type B+			
RCMS410-24	DC 24 V	X	(X) with function module B	Factory settings, function modules	Customised (A, B, C can be bought later)	B84604040
		X	X	-	B (A and C can be bought later)	B84604041
		X	X	-	A, B, C	B84604042

* Function modules:

A: Harmonic analysis (FFT)

B: AC/DC sensitive measuring and evaluation of values

C: Connection of type A external current transformers

8.7 Document revision history

Date	Document version	Status/changes
09.2022	00	Initial edition
03.2023	01	Added Chapter "PROTECT" function" Chapter "8.7 Document revision history" Editorial revision Chapter "2.2 Functional description" Note in chapter "4.5.1 Measuring-current-transformer connection" Curves "8.1 Frequency responses of the filters" Chapter "8.2 Tabular data" Chapter "8.3 Standards & certifications" Chapter "8.6 Ordering information"
05.2023	02	Corrected Naming of the function modules in the document



Alle Rechte vorbehalten.
Nachdruck und Vervielfältigung
nur mit Genehmigung des Herausgebers.

Bender GmbH & Co. KG

Postfach 1161 • 35301 Grünberg • Deutschland
Londorfer Str. 65 • 35305 Grünberg • Deutschland
Tel.: +49 6401 807-0 • Fax: +49 6401 807-259
E-mail: info@bender.de • www.bender.de



All rights reserved.
Reprinting and duplicating
only with permission of the publisher.

Bender GmbH & Co. KG

PO Box 1161 • 35301 Gruenberg • Germany
Londorfer Str. 65 • 35305 Gruenberg • Germany
Tel.: +49 6401 807-0 • Fax: +49 6401 807-259
E-mail: info@bender.de • www.bender.de